



Instant Digital Camera

User's Manual



Questions? Need some help?

This manual should help you understand your new product.

If you still have questions, call our help line found on the insert with this icon:



Or visit
www.polaroid.com/support.

Digital Quality, Polaroid Simplicity™

FCC STATEMENT

This device complies with Part 15 of the FCC Rules. Operation is subject to the following two conditions:

- (1) This device may not cause harmful interference, and
- (2) This device must accept any interference received, including interference that may cause undesired operation.

Note:

This equipment has been tested and found to comply with the limits for Class B digital devices, pursuant to Part 15 of the FCC rules. These limits are designed to provide reasonable protection against harmful interference in a residential installation. This equipment generates uses and can radiate radio frequency energy and, if not installed and used in accordance with the instructions, may cause harmful interference to radio communications. However, there is no guarantee that interference will not occur in a particular installation. If this equipment does cause harmful interference to radio or television reception, which can be determined by turning the equipment off and on, the user is encouraged to try to correct the interference by one or more of the following measures:

- Reorient or relocate the receiving antenna.
- Increase the separation between the equipment and receiver.
- Connect the equipment into an outlet on a circuit different from that to which the receiver is connected.
- Consult the dealer or an experienced radio/TV technician for help.

Use of shielded cable is required to comply with Class B limits in Subpart B of Part 15 of the FCC rules.

Do not make any changes or modifications to the equipment unless otherwise specified in the manual. If such changes or modifications should be made, you could be required to stop operation of the equipment.

Notice

If static electricity or electromagnetism causes data transfer to discontinue midway (fail), restart the application or disconnect and connect the communication cable (USB, etc.) again.



©2008 by  Polaroid All rights reserved.

"Polaroid", "Polaroid and Pixel", and "Polaroid PoGo" are trademarks of Polaroid Corporation. The ZINK™ Technology and ZINK™ trademarks are owned by ZINK Imaging, Inc. Used under license.

Changes are periodically made to this document. Changes, technical inaccuracies, and typographic errors will be corrected in subsequent editions.

For service, support and warranty information, visit www.polaroid.com.



This product contains electrical or electronic materials. The presence of these materials may, if not disposed of properly, have potential adverse effects on the environment and human health. Presence of this label on the product means it should not be disposed of as unsorted waste and must be collected separately. As a consumer, you are responsible for ensuring that this product is disposed of properly. To find out how to properly dispose of this product, please go to www.polaroid.com and click on Company or call the customer service number for your country listed in the instruction manual.

READ THIS FIRST

Trademark Information

- Microsoft® and Windows® are U.S. registered trademarks of Microsoft Corporation.
- Pentium® is a registered trademark of Intel Corporation.
- Macintosh is a trademark of Apple Inc.
- SD™ is a trademark.
- Other names and products may be trademarks or registered trademarks of their respective owners.

Product Information

- Product design and specifications are subject to change without notice. This includes primary product specifications, software, software drivers, and user's manual. This User Manual is a general reference guide for the product.
- The product and accessories that come with your camera may be different from those described in this manual. Retailers often specify slightly different product inclusions and accessories to suit their market requirements, customer demographics, and geographical preferences. Products very often vary between retailers especially with accessories such as batteries, chargers, AC adapters, memory cards, cables, pouches, and language support. Occasionally a retailer will specify a unique product color, appearance, and internal memory capacity. Contact your dealer for precise product definition and included accessories.
- The illustrations in this manual are for the purposes of explanation and may differ from your camera.
- The manufacturer assumes no liability for any errors or discrepancies in this user manual.

SAFETY INSTRUCTIONS

Please read all **Warnings** and **Cautions** before using this product.

Warnings

If foreign objects or water enter the camera, turn the power off and remove the battery.

Continued use may cause personal injury. Please consult our friendly customer service.



If the camera has been dropped or its case has been damaged, turn the power off and remove the battery.

Continued use may cause personal injury. Please consult our friendly customer service.



Do not disassemble, change or repair the camera.

Service should only be performed by a qualified technician. Please contact our friendly customer service should you have any questions.



Do not use the camera in areas near water.

Continued use may cause personal injury. Please consult our friendly customer service.



Do not place the camera on unstable surfaces.

This might cause the camera to fall and cause damage.



Keep the battery out of the reach of children.

Adult supervision is recommended when the product is being operated by young children.



Do not use the camera while you are walking, driving or riding a motorcycle.

This may result in you having an accident.



For optimal performance please use the camera at temperatures between 60°F and 90°F (15.6°C and 32.2°C) and humidities between 20 to 80%.



Do not use the camera near sand as this may damage the camera.



Cautions

Do not fire the flash close to anyone's eyes.

This may cause damage to the person's eyesight.



Do not subject the LCD display to impact.

This may damage the glass on the screen or cause the internal fluid to leak. If the internal fluid comes in contact with your eyes, flush with fresh water and seek medical attention.



A camera is a precision instrument. Do not drop, strike or use excessive force when handling the camera.

This may cause damage to the camera.



Do not use the camera in humid, steamy, smoky, or dusty places.

This may cause fire or electric shock.



Do not immediately remove the battery after a long period of continuous use.

The battery may become warm during continued use; this is normal. Touching a warm battery may cause personal injury.



Do not wrap the camera or place it in cloth or blankets.

This may cause heat to build up and deform the case, resulting in personal injury. Use the camera in a well-ventilated area.



Do not leave the camera in places where the temperature may rise significantly, such as the inside a car.

This may adversely affect the performance of the product.



Before moving the camera, disconnect all cords and cables.

Failure to do this may damage cords and cables, resulting in personal injury or damage to the product.



Notes on Battery Usage

When you use the battery, carefully read and strictly observe the **Safety Instructions** and the notes described below:

- Use only the specified battery (7.4V).
- Avoid extremely cold environments as low temperatures can shorten the battery life and reduce camera performance.
- When you are using a new rechargeable battery or a rechargeable battery that has not been used for an extended period of time (a battery that passed the expiry date is an exception), it may affect the number of images that can be captured. To maximize its performance and lifetime, we recommend that you fully charge the battery and discharge it for at least one complete cycle before use.
- The camera may feel warm after a long period of continuous use. This is normal and not a malfunction.
- If the battery is not to be used for a long period of time, remove it from the camera. If stored for a long time in a fully charged condition, its performance may be impaired.
- Always keep the battery terminals clean.
- Only use the specified battery or its equivalent with this product.
- Properly dispose the battery when it will no longer charge.
- Do not short the terminals of the battery.

Questions?

Call our toll-free customer service number. Look for the insert with this icon:

Or visit www.polaroid.com.



Notes on Handling Polaroid PoGo™ ZINK Photo Paper™ and Print Care

- Keep the photo pack in a cool and dry place.
- Do not leave the photo pack in a place where the temperature is extremely high (e.g. a car or on the beach) for long periods.
- If the photo pack has been kept in a place where the temperature is extremely high or low, leave it at normal room temperature for an hour before starting to print.
- When holding the paper, only touch the edges of the paper.
- Do not touch or pull the print during printing.
- Do not bend, fold or scratch prints and avoid touching the print surface.
- Do not leave the prints in extremely hot locations (such as on hot sand, concrete or close to a heating appliance).
- Keep the prints in a cool and dry place.
- Do not store the photo pack and prints in moist areas (store them in areas that have less than 20% humidity).

CONTENTS

8 INTRODUCTION

- 8 Overview
- 8 Package Contents

9 GETTING TO KNOW YOUR CAMERA

- 9 Front View
- 10 Rear View
- 11 LCD Display

13 GETTING STARTED

- 13 Preparation
- 14 Installing Polaroid PoGo™ ZINK Photo Paper™
- 15 Charging the Battery
- 16 Initial Settings

18 CAPTURE MODE

- 18 Capturing Images
- 19 Setting the Self-timer
- 20 Setting the Scene Mode
- 20 Setting Manual White Balance
- 21 Recording a Subject onto an Existing Background Image
- 21 Combining Shots of Two People into a Single Image

22 VIDEO MODE

- 22 Recording Video Clips
- 22 Playing Back Video Clips

23 PLAYBACK MODE

- 23 Playback of Still Images
- 24 Attaching Voice Memos
- 25 Protecting Images
- 26 Erasing Images

27 INSTANT DIGITAL PRINTER FUNCTIONS AND FEATURES

- 28 Editing your Images

30 MENU OPTIONS

- 30 Capture Menu
- 33 Video Menu
- 34 Playback Menu
- 35 Setup Menu

36 TRANSFERRING FILES TO YOUR COMPUTER

- 36 Downloading Your Files

37 USING THE CAMERA AS A PC CAMERA

38 EDITING SOFTWARE INSTALLATION

39 SPECIFICATIONS

40 APPENDIX

- 40 Possible Number of Shots
- 41 Troubleshooting
- 43 Quick Printing
- 44 Connecting to a PictBridge Compliant Printer
- 46 Default Settings

INTRODUCTION

Overview

Congratulations on your purchase of your new Polaroid PoGo™ Instant Digital Camera. This camera is a full featured digital camera with built-in full color printer. Take digital images like any other digital camera, review them on this camera, and print just the ones you want.

Package Contents

Carefully unpack your camera and ensure that you have the following items:

- Instant Digital Camera
- User's manual
- Software CD-ROM
- USB cable
- Camera strap
- Camera pouch
- Rechargeable lithium-ion battery
- AC power adapter
- AC power cord
- 10 sheets ZINK Photo Paper™

Optional Accessories:

- SD/SDHC memory card (We recommend the use of a Polaroid SD card - purchased separately - up to 4GB)



-
- Accessories and components may vary by retailer.
 - Should any of these components be missing, please call our friendly customer service to assist you.

GETTING TO KNOW YOUR CAMERA

Front View

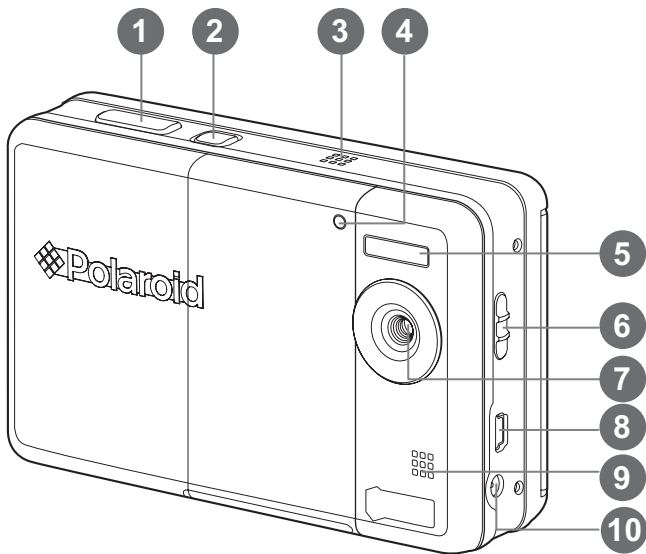

1. Shutter button
2.  Power button
3. Speaker
4. Self-timer LED
5. Flash
6. Focus switch
7. Lens
8. USB terminal
9. Microphone
10. DC IN 9V terminal

Rear View

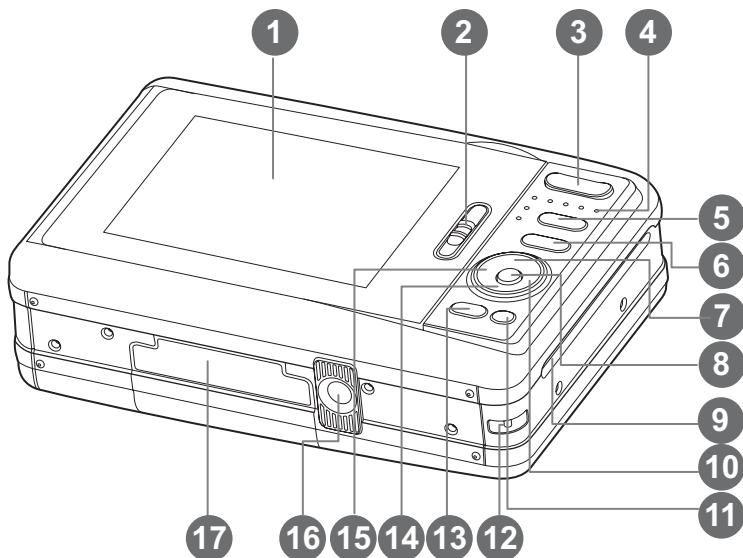

1. LCD display
2. Paper tray door latch
3. **T** Zoom in button
W Zoom out button
4. Status LED
5. Mode button (Image capture and playback)
6. Menu button
7. Up button
 Display button
8. **OK** Set button
9. Photo exit slot

10. Right button
 Flash mode button
11. Delete button
12. Hand strap holder
13. **PRINT** Print button
14. Down button
SCN/ Scene button
15. Left button
 Self-timer button
16. Tripod socket
17. Battery / SD card door

LCD Display

Capture mode

1. Zoom status
2. Flash mode
 [Blank] Auto Flash
 [] Red-eye Reduction
 [] Pre-flash
 [] Always ON
 [] Flash Off
3. Battery level
 [] Full battery power
 [] Medium battery power
 [] Low battery power
 [] No battery power
4. Storage media
 [] Internal memory (no card)
 [] SD/SDHC memory card
5. ISO
 [Blank] Auto
 [] ISO 100
 [] ISO 200
 [] ISO 400
6. Main focus area
7. Image quality
 [] Fine
 [] Standard
 [] Economy
8. Image size resolution
 [] 3072 x 2304 (FW interpolation)
 [] 2560 x 1920
 [] 2048 x 1536
 [] 1280 x 960
 [VGA] 640 x 480
9. Available number of shots
10. Date and time
11. [] Exposure compensation
 (Adjust exposure compensation value with the ◀ / ▶ buttons)
12. Capture mode icon
 [Blank] Single
 [] Continuous
 [] Auto Exposure Bracketing
 [] Burst
 [] Series + flash
 [] Pre-Shot
 [] Couple Shot

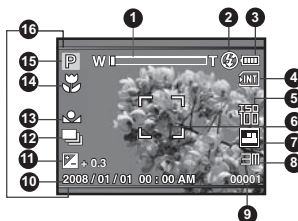

13. White balance
 [Blank] Auto
 [] Tungsten
 [] Fluorescent 1
 [] Fluorescent 2
 [] Daylight
 [] Cloudy
 [] Manual
14. Focus setting
 [Blank] Normal
 [] Macro
15. Scene mode
 [P] Program AE
 [] Landscape
 [] Fireworks
 [] Flow Water
 [] Splash Water
 [] Portrait Man
 [] Portrait Lady
 [] Sports
 [] Text
 [] Snow
 [] Beach
 [] Sunset
 [] Sunrise
 [] Night Scene
 [] Night Portrait
 [] Pets
 [] Video
 [] Candlelight
 [] User Setting
16. 2 x 3 Print Preview Frame
 (Framing your subject within this frame prevents inadvertent cropping)

Video mode [📹]

1. Zoom status
2. Flash mode
3. Battery level
4. Storage media
5. Main focus area
6. Video quality
7. Video resolution
8. Available recording time/Elapsed time during recording
9. Self-timer icon
10. Date and time
11. Focus setting
12. Mode icon

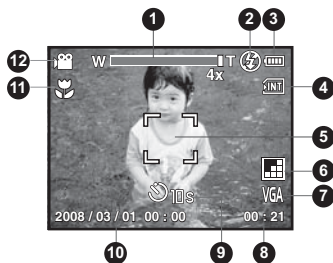

Playback mode [🖼️] - Still image playback

1. Battery level
2. Storage media
3. ISO
4. Image quality
5. Image size resolution
6. File number
7. Folder number
8. Date and time
9. Exposure value
10. Aperture value
11. Shutter speed value
12. Protect icon
13. Mode icon

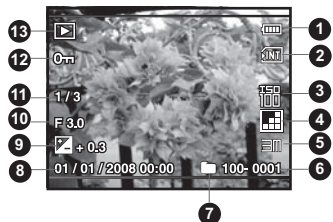

Playback mode [📺] - Video playback

1. Video status bar
2. Elapsed time
3. File number
4. Folder number
5. Sound off icon (When the ▲ button is pressed during video playback)
6. Play mode
7. Mode icon
8. Total recorded time



GETTING STARTED

Preparation

1. Attach the camera's hand strap as shown in the illustration.

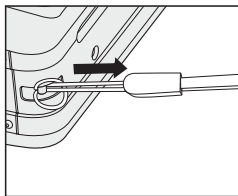

2. Open the battery/SD card door.
3. Insert the battery in the correct orientation as shown in the illustration.

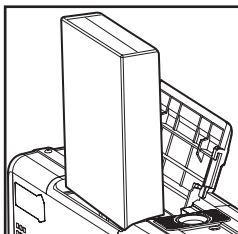

4. Insert an SD/SDHC memory card (Optional).
 - The camera has 16MB internal memory (4MB available for image storage), but you can load an SD/SDHC memory card (We recommend the use of a Polaroid SD card - purchased separately - up to 4GB) to expand the camera's memory capacity.
 - Be sure to format the memory card with this camera before its initial usage.
5. Close the battery/SD card door and make sure it is locked securely.

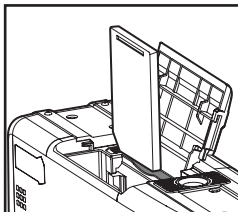

- To prevent valuable data from being accidentally erased from an SD/SDHC memory card, you can slide the write protect tab (on the side of the SD/SDHC memory card) to "LOCK".
- To save, edit, or erase data on an SD/SDHC memory card, you must unlock the card.
- To prevent damaging of an SD/SDHC memory card, be sure to turn off the power when inserting or removing the SD/SDHC memory card. If inserting or removing the SD/SDHC memory card with the power on, the camera will automatically turn off.

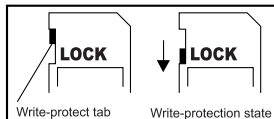

Installing Polaroid PoGo™ ZINK Photo Paper™

Insert the photo paper before printing images.

1. Slide the latch on the paper tray door as shown in the illustration.

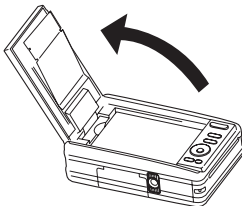
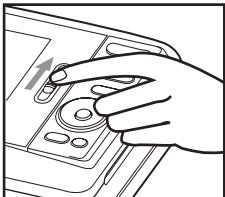

2. Unwrap the 10-pack of Polaroid PoGo™ ZINK Photo Paper™.

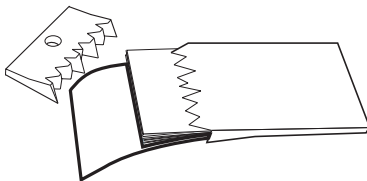

3. Slide the 10-pack of Polaroid PoGo™ ZINK Photo Paper™ into the paper tray.

- Make sure the ZINK Smart Sheet™ is placed and loaded with the bar code face down.
- Shiny side of paper faces up.

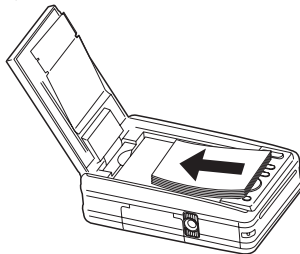

4. Close the paper tray door.

- The ZINK Smart Sheet™ will automatically eject.



-
- The paper compartment must be empty before refilling. Do not fill the paper compartment with more than one 10-pack of ZINK Photo Paper™. Having more than 10 sheets of paper may damage the printer.
 - Avoid bending the ZINK Photo Paper™.
 - Only hold the ZINK Photo Paper™ by its edges; avoid touching the printing surface with your fingers.

Charging the Battery

The AC power adapter charges the battery and also powers the camera. Make sure that the camera is turned off and the battery is inserted before starting.

1. Insert one end of the AC power adapter into the DC IN 9V terminal of the camera.
2. Insert the other end of the AC power adapter into a wall outlet.

- The status LED is orange when charging and is green when charging is complete.
- Charging time varies according to the ambient temperature and the age of the battery.

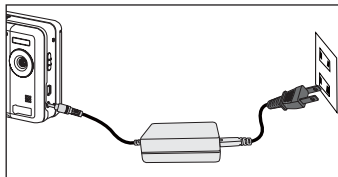

-
- The battery may feel warm after it has been charged or immediately after being used. This is normal and not a malfunction.
 - When using the camera in cold areas, keep the camera and battery warm.

Initial Settings

Setting the Date and Time

The date/time needs to be set when:

- The camera is turned on for the first time.
- The camera is turned on after leaving the camera without the battery for an extended period of time.









When the date and time information is not displayed on the LCD display, follow these steps to set the correct date and time.

1. Toggle the button to [].
2. Press the button.
3. Select [Setup] with the button.
4. Select [Date/Time] with the / buttons, and press the **OK** button.
5. Select the date format with the / buttons, and press the **OK** button.
6. Select the time format with the / buttons, and press the **OK** button.
 - Select the appropriate field with the / buttons and adjust the value for the date and time with the / buttons.
 - When your settings are correct, press the **OK** button.
7. To exit from the [Setup] menu, press the button.



Choosing your Language









Specify what language in the menus and messages are to be displayed on the LCD display.

1. Toggle the  button to [] or [].
2. Press the  button.
3. Select [Setup] menu with the  button.
4. Select [Language] with the  /  buttons and press the **OK** button.
5. Select the displayed language with the  /  buttons and press the **OK** button.
 - The setting will be stored.



Formatting the Memory Card or Internal Memory

This utility formats the internal memory (or memory card) and erases all stored images and data.

1. Toggle the  button to [].
2. Press the  button.
3. Select [Setup] menu with  button.
4. Select [Format] with the  /  buttons, then press the **OK** button.
5. Select [Execute] with the  /  buttons, and press the **OK** button.
 - To cancel formatting, select [Cancel] and press the **OK** button.

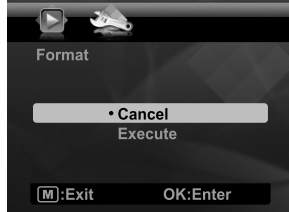

- Photos or movies deleted by formatting cannot be recovered. Download photos and movies to your computer before you format the memory card.

CAPTURE MODE

Capturing Images

Your camera is equipped with a 3.0" full color TFT LCD display to help you compose images, playback recorded images/video clips or adjust menu settings.

1. Press the **⏻** button to turn the power on.
2. Toggle the **📷** button to [**📷**].
 - Set the focus switch to [**👤**] if you want to capture a close-up image (0.6 to 1.45m: 2 to 5 feet).
 - Toggle the **⚡** button to select the appropriate flash mode setting. If flash mode is set to **⚡**, this "Pre-flash" mode allows you to brighten the subject prior to taking the final picture and firing the flash.
3. Compose your image in the LCD display.
 - Pressing the **T** button zooms in on the subject, and enlarges the subject on the LCD display.
 - Pressing the **W** button provides a wider angle image.
4. To take a picture press the shutter button.

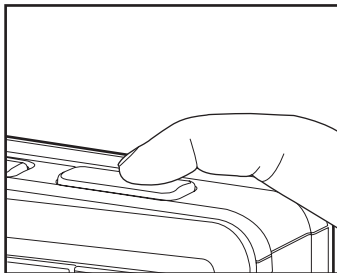

Questions?



Call our toll-free customer service number. Look for the insert with this icon:

Or visit www.polaroid.com.





Setting the Self-timer





This setting allows images to be captured with self-timer.

1. Toggle the  button to select the setting.
 - Each press of the  button moves the icon one step through the sequence and displays it on the screen.
2. Compose your image in the LCD display.
3. Press the shutter button.
 - The self-timer LED flashes and the camera beeps (if beep is turned on). The image will be captured after the preset time has elapsed.
 - The countdown is displayed on the LCD screen.
 - To cancel the self-timer during operation, press the **OK** button or shutter button.

The table below will help you to choose the appropriate self-timer mode:

Self-timer mode	Description
[ 2s] 2 sec.	The image is captured about 2 seconds after the shutter is pressed.
[ 10s] 10 sec.	The image is captured about 10 seconds after the shutter is pressed.
[ 10+2s] 10+2 sec.	The first image is captured about 10 seconds after the shutter button is pressed, and then a second image is captured 2 seconds later. The 10+2 mode is convenient when capturing group images in succession.



- The "10+2 sec." self-timer function cannot be used in the following capture modes: [], [], [], [], [], [], [

Setting the Scene Mode

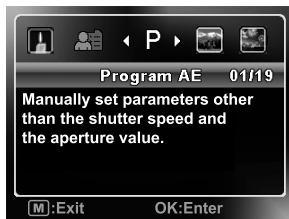

By simply selecting one of the available 19 scene modes, you can capture the image with the most appropriate settings.

1. Press the **SCN**/ button.
2. Select the desired scene mode with the **◀ / ▶** buttons, and press the **OK** button.
3. Compose your image and press the shutter button.



Setting Manual White Balance

This manually sets the white balance and stores it. Use this feature if one of the pre-selected white balance lighting settings does not produce overall good image quality for the lighting used in your image.

1. Toggle the  button to [].
2. Press the **(M)** button.
3. Select [White Balance] with the **▲ / ▼** buttons, and press the **OK** button.
4. Select [Manual] with the **▲ / ▼** buttons, and press the **OK** button.
5. Select [New WB] with the **▲ / ▼** buttons, and press the **OK** button.
 - To use the previously set white balance data, select [Use Data], and press the **OK** button.
6. Place a white paper in the middle of the scene, with all lights that will be used in the photo turned on. Zoom in on the paper, so it almost fills the frame. Then, select [Execute] from the Manual WB menu.
 - This establishes for the camera exactly what white should look like under the current lighting conditions, and it will adjust its white balance accordingly.
 - The setting is memorized and will remain if the camera is shut off then back on.

Recording a Subject onto an Existing Background Image

Pre-Shot helps you get the background you want, even if you need to ask someone else to record the image for you. Basically, Pre-Shot is a two-step process.

1. Toggle the **☐▶** button to [**P**].
 - a. Press the **M** button.
 - b. Select [Function] with the **▶** button.
 - c. Select [Capture Mode] with the **▲ / ▼** button, and press the **OK** button.
 - d. Select [Pre-Shot] with the **▲ / ▼** button, and press the **OK** button.
 - e. Press the **M** button to exit from the menu screen.
2. Compose the background you want on the screen, and then press the shutter button to temporarily record it as a reference image.
 - This operation causes a semi-transparent image of the background to appear on the screen, but the displayed image is not actually saved in camera memory.
3. Now you can stand in front of the background and ask someone else to take your picture, using the semi-transparent background on the screen as a composition guide.
4. After composing the final image (using the semi-transparent background as a guide), the person with the camera should press the shutter button to record.
 - Note that the semi-transparent background image temporarily recorded in step 2 is for composition purposes only. The final image contains only what is in front of the camera when the shutter button is pressed in step 4.

Combining Shots of Two People into a Single Image

This mode lets you record images of two people and combine them into a single image. This makes it possible for you to include yourself in group images, even when there is no one else around to record the image for you.

1. Toggle the **☐▶** button to [**P**].
 - a. Press the **M** button.
 - b. Select [Function] with the **▶** button.
 - c. Select [Capture Mode] with the **▲ / ▼** button, and press the **OK** button.
 - d. Select [Couple Shot] with the **▲ / ▼** button, and press the **OK** button.
 - e. Press the **M** button to exit from the menu screen.
2. Align the subject you want on the left side of the image.
3. Press the shutter button to record the left side of the image.
4. Next compose the subject you want in the right side of the image, taking care to align the background with the semi-transparent image of the background of the first image, which is shown on the screen.
5. When everything is aligned correctly, press the shutter button to record the right side of the image.

VIDEO MODE

Recording Video Clips

This mode allows you to record video clips at a resolution of 320 x 240 / 640 x 480 pixels.

1. Press the **SCN/** button.
2. Select [Video] with the **◀ / ▶** buttons, and press the **OK** button.
3. Compose the image.
4. Press the shutter button.
 - The recording starts.
 - Pressing the shutter button again and the recording stops.
 - The recording time depends on the available memory on the memory card and the subject of the image being recorded.
 - The maximum recording time is 60 minutes per video.
 - The zoom function cannot be used during video recording.

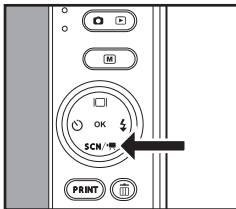

-
- When recording a video clip, the flash and "10+2 sec." self-timer function cannot be used.
 - If the write speed of your SD/SDHC memory card is not fast enough for recording video clips in the currently selected quality, the video recording will stop. Should this happen, select a lower video quality.

Playing Back Video Clips

You can play back recorded video clips on the camera. You can also play back sound if recorded with the video.

1. Toggle the **▶** button to [**▶**].
 - The last image appears on the screen.
2. Select the desired video clip with the **◀ / ▶** buttons.
3. Press the **OK** button.
 - A press of the **▶ / ◀** buttons during playback allows fast forward / fast reverse playback.
 - To stop video playback, press the **▼** button. This stops playback and returns you to the beginning of the video clip.
 - To pause video playback, press the **OK** button. Pressing the **OK** button again resumes playback.









-
- Video clips cannot be displayed rotated or enlarged.
 - Windows Media player or QuickTime Player is recommended to play back the video clip on your computer.
 - QuickTime Player is a free media player available at www.apple.com, and compatible with Mac and Windows computers.
 - For more information about the operation of the media player, refer to its respective help documentation.

PLAYBACK MODE

Playback of Still Images

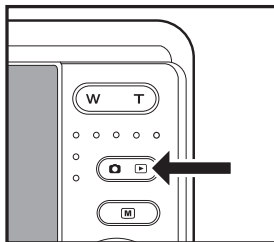

You can play back your still images on the LCD display.

1. Toggle the  button to [].
 - The last image appears on the screen.
2. The images can be displayed in forward or reverse sequence using the  /  buttons.
 - To view the previous image, press the  button.
 - To view the next image, press the  button.
 - Pressing the  button during image playback will result in a 90-degree clockwise rotation display.
 - Pressing the **T** button enlarges the image.
 - To return to normal magnification, press the **W** button.













Entire image Current position of enlargement



- An [] icon is displayed with the video data. Video clips cannot be rotated.
- An [] icon is displayed with images which have an audio memo recorded.

Attaching Voice Memos

You may record a voice memo for a still image (up to 30 seconds in length). Only one voice memo per image.

1. Toggle the  button to [].
 - The last image appears on the screen.
2. Select the image to which you want to attach the voice memo with the  /  buttons.
3. Press the  button.
4. Select [Voice Memo] with the  /  buttons, and press the **OK** button.
5. Select [On] with the  /  buttons, and press the **OK** button.
6. Press the  button to exit from the menu.
7. Press the shutter button.
 - [VOICE RECORDING] is displayed on the screen and the recording starts.
8. To stop recording, press the shutter button again.
 - [VOICE RECORD END] will be displayed and the recording will end. An  icon is displayed with images that have a voice memo.

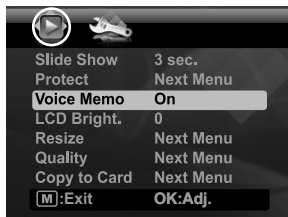

Playing back voice memo



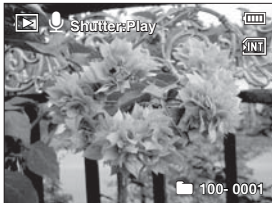









Pressing the shutter button with an image that has a VOICE MEMO recorded starts the VOICE MEMO playback.



- Voice memo is only available for still images.

Protecting Images







To prevent images from accidentally being erased, follow the steps below:

1. Toggle the  button to [].
2. Select the image that you want to protect with the  /  buttons.
3. Press the  button.
4. Select [Protect] with the  /  buttons, and press the **OK** button.
5. Select [Single] or [All] with the  /  buttons, and press the **OK** button.
6. Select [Set] with the  /  buttons, and press the **OK** button.
 - Protection is applied to the image and the camera returns to the playback mode.
 - The protect icon [] is displayed with protected images.
When [All] has been selected, [] is displayed on all the images.



Canceling the Protection









To cancel protection for only one image, display the image on the LCD display you want to remove the protection.

1. Select [Protect] with the  /  buttons from the playback menu, and press the **OK** button.
2. Select [Single] or [All] with the  /  buttons, and press the **OK** button.
3. Select [Cancel Protect] with the  /  buttons, and press the **OK** button.
 - The removal of image protection is executed and the camera returns to the playback mode.



- Formatting an SD/SDHC memory card overrides protection, and erases all images regardless of their protected status.

Erasing Images

1. Toggle the  button to [].
2. Select the image you want to erase with the  /  buttons.
3. Press the  button.
4. Select [Single] or [All] with the  /  buttons, and press the **OK** button.
 - [Single]: Erases the selected image or the last image.
 - [All]: Erases all of the images except for the protected images.
5. Select [Execute] with the  /  buttons, and press the **OK** button.
 - To not erase, select [Cancel], and press the **OK** button.



- Deleting an image will not affect sequential image numbering. For example, if you delete image number 240, the next captured image will be numbered 241 even though 240 no longer exists. In other words, an image-number is retired when an image is deleted and will not be reused or reassigned to another subsequently captured image.
- When black text is highlighted green it is the command that will be executed when you press the **OK** button. For example, if [Cancel] is highlighted in green and you press the **OK** button you will not delete this picture.

INSTANT DIGITAL PRINTER FUNCTIONS AND FEATURES

1. Press the **PRINT** button.
2. Select [Print] with the ▲ / ▼ buttons, and press the **OK** button.
3. Select the image that you want to print with the ◀ / ▶ buttons, and press the **OK** button.
 - By default the print quantity is 1.
 - Press the [M] button to exit the menu mode, and the camera returns to preview display.

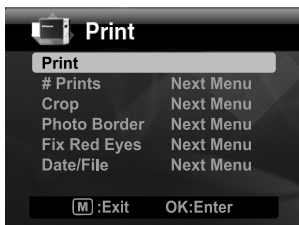

Setting the number of prints

After selecting your image that you want to print, if you wish to change the print quantity, select [# Prints] on the print menu. Set the desired quantity with the ▲ / ▼ buttons. Press the **OK** button to start printing the selected image.

- After the printing process is complete, the camera returns to the main Print menu.

If you wish to print multiple, different images do the following:

- a. Press the **PRINT** button.
- b. Select [# Prints] by using the ▲ / ▼ buttons.
- c. Press the **OK** button.
- d. Use the ▲ / ▼ buttons to select the number of prints for this image.
- e. Use the ◀ / ▶ buttons to select the next print.
- f. Repeat step d through e to select your other images and number of prints of each.
- h. Press the **OK** button to start printing the selected image.
 - After the printing process is complete, the camera returns to the main Print menu.

Editing your Images

The camera has features that allow you to perform several photo editing functions on your images before printing. You can remove red-eye effects, crop images to specific sizes and more.

Cropping Images

- After selecting your image in the review mode, press the **PRINT** button. Opt for the [Crop] feature with the **▲ / ▼** buttons, and press the **OK** button.
- Select the image that you want to edit with the **◀ / ▶** buttons.
- Press the **OK** button again to enter the cropping mode. You should see the highlighted crop box.
- Press the **W / T** buttons.
 - Pressing the **T** button enlarges the image.
 - To return to normal magnification, press the **W** button.
- Press the **▲ / ▼ / ◀ / ▶** buttons to select the image portion that you want to crop and press the **OK** button.
- Select [Yes] with the **◀ / ▶** buttons, and press the **OK** button. The cropped image is saved as a new file.
- To proceed with image printing, select [Yes] with the **◀ / ▶** buttons on the "Print Now?" menu.
 - After the printing process is complete, the camera returns to the main Print menu.



Adding Photo Border

- After selecting your image in the review mode, press the **PRINT** button. Opt for the [Photo Border] feature with the **▲ / ▼** buttons, and press the **OK** button.
- Select the image that you want to edit with the **◀ / ▶** buttons.
- Press the **OK** button again to enter the border mode. You should see the border frame on your image box.
- Select the photo border that you want to choose with the **◀ / ▶** buttons, and press the **OK** button.
- Select [Yes] with the **◀ / ▶** buttons, and press the **OK** button. The new bordered image is saved as a new file.
- To proceed with image printing, select [Yes] with the **◀ / ▶** buttons on the "Print Now?" menu.
 - After the printing process is complete, the camera returns to the main Print menu.



Removing Red-eye Effects

- a. After selecting your image in the review mode, press the **PRINT** button. Opt for the [Fix Red Eyes] feature with the ▲ / ▼ buttons, and press the **OK** button.
- b. Select the image that you want to edit with the ◀ / ▶ buttons, and press the **OK** button.
 - The camera will automatically remove your subject's red eyes.
 - After it processes, you can preview your new image.
- c. Press the **OK** button to save this improved image as a new file.
- d. To proceed with image printing, select [Yes] with the ◀ / ▶ buttons on the "Print Now?" menu.
 - After the printing process is complete, the camera returns to the main Print menu.

Adding Data Imprint

- a. After selecting your image in the review mode, press the **PRINT** button. Opt for the [Date/File] feature with the ▲ / ▼ buttons, and press **OK** button.
- b. Select the data that you want to print on your image with the ▲ / ▼ buttons, and press the **OK** button.
 - If you wish to print this image, select [Print] on print menu and press the **OK** button.
 - Should you select date or date & file, the print data will be the date the image was printed; not the date the image was taken.

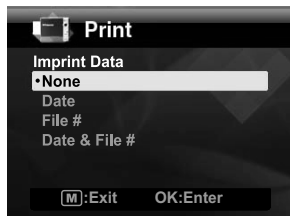

-
- Do not turn off the camera while printing.
 - Do not open the paper tray door while printing.

MENU OPTIONS

Capture Menu

This menu is for the basic settings to be used when capturing still images.

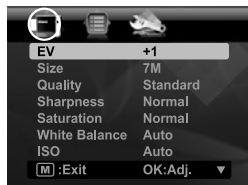

[Capture]



[Capture]

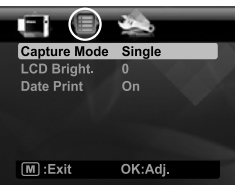

[Function]

1. Toggle the button to [].
2. Press the button, and select the [Capture] / [Function] menu with the / buttons.
3. Select the desired option with the / buttons, and press the **OK** button to enter its respective menu.
4. Select the desired setting with the / buttons, and press the **OK** button.
5. To exit from the menu, press the button.

EV

Your camera adjusts the exposure of each shot automatically. However, if the subject is very dark, or very bright, you may override the camera's automatic exposure setting to make the subject brighter or darker. This is called EV compensation. The EV compensation can be adjusted from -2.0EV to +2.0EV.

Size

This sets the size of the image that will be captured.

- * [] 3072 x 2304 (FW interpolation)
- * [] 2560 x 1920
- * [] 2048 x 1536
- * [] 1280 x 960
- * [] 640 x 480

Quality

This sets the quality (compression) at which the image is captured.

- * [] Fine
- * [] Standard
- * [] Economy

Questions?

Call our toll-free customer service number. Look for the insert with this icon:

Or visit www.polaroid.com.



Sharpness

This sets the sharpness of the image that will be captured.

* Hard / Normal / Soft

Saturation

This sets the saturation of the image that will be captured.

* High / Normal / Low

White Balance

This sets the white balance for a variety of lighting conditions and adjusts the images overall color according to the surrounding light conditions. Use this function if image color appears unnatural.

* [Blank] Auto (for most photographic scenes)

* [] Tungsten

* [] Fluorescent 1

* [] Fluorescent 2

* [] Daylight

* [] Cloudy

* [] Manual (Refer to the section in this manual titled "Setting Manual White Balance" for further details.)

ISO

This sets the sensitivity for capturing images. When the sensitivity is raised (and the ISO number is increased), images taken under low lighting or darker areas of the image will be seen, but the image may be more pixelated/grainier overall. As a "rule of thumb" the higher the ISO value the more grain in the image.

* [Blank] Auto

* [] ISO 100

* [] ISO 200

* [] ISO 400

Metering

This sets the metering method for calculating the exposure.

* Center: Averages the light metered from the entire frame, but gives greater weight to the subject matter at the center.

* Multi: The entire area of the screen is measured, and the exposure is calculated.

* Spot: A very small portion of the center of the screen is measured to calculate the correct exposure.







Color

This sets the overall color of the image that will be captured.

* Normal / Vivid / Sepia / Monochrome / Blue / Red / Green / Yellow / Purple

Capture Mode

This sets the recording method at the time of capturing images.

- * [Blank] Single: Captures one image at a time.
- * [] Continuous: Permits continuous capture of up to 3. The flash is disabled in this mode.
- * [] AEB (Automatic Exposure Bracketing): Permits 3 consecutive images taken in the following order; standard exposure, underexposure and overexposure compensation.
- * [] Burst: Permits continuous photography while pressing and holding the shutter button. As long as you hold the shutter button pressed, images are captured until the memory capacity is full.
- * [] Series+flash: Permits continuous capture of up to 3 images with flash.
- * [] Pre-Shot: Lets you capture the background first, then have someone to capture you in front of it. Refer to the section in this manual titled "Recording a Subject onto an Existing Background Image" for further details.
- * [] Couple Shot: Uses a "split-screen" feature to combine two shots. You can include yourself in the shot. Refer to the section in this manual titled "Combining Shots of Two People into a Single Image " for further details.

LCD Bright.

Adjust the brightness level of the LCD display to your desired setting.

The LCD becomes brighter with the ▲ button and darker with the ▼ button. The adjustment range is from -5 to 5.

Date Print

The date the image was captured will be printed on it. This function must be activated before the image is captured.

* On / Off

Video Menu

This menu is for the basic settings to be used when recording video clips.



[Capture]

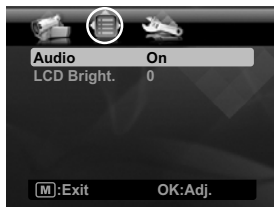

[Function]

1. Press the **SCN**/**▶** button.
2. Select [Video] with the **◀** / **▶** buttons, and press the **OK** button.
3. Press the **[M]** button, and select the [Capture] / [Function] menu with the **◀** / **▶** buttons.
4. Select the desired option with the **▲** / **▼** buttons, and press the **OK** button to enter its respective menu.
5. Select the desired setting with the **▲** / **▼** buttons, and press the **OK** button.
6. To exit from the menu, press the **[M]** button.

Size

This sets the size of the video clip that will be captured.

* **[VGA]** 640 x 480

* **[VGA]** 320 x 240

Quality

This sets the quality (compression) at which the video clip is captured.

* **[Fine]** Fine

* **[Standard]** Standard

Color

This sets the overall color of the video clip that will be captured.

* Normal / Vivid / Sepia / Monochrome / Blue / Red / Green / Yellow / Purple

Audio

This sets whether or not to record audio when recording.

* On / Off



LCD Bright.

Refer to the section in this manual titled "LCD Bright." in Capture Menu for further details.

Playback Menu

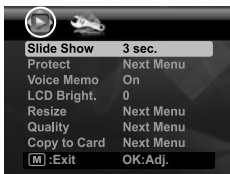
In the [] mode, choose which settings are to be used for playback.



1. Toggle the  button to [].
2. Press the [**M**] button.
3. Select the desired option with the **▲** / **▼** buttons, and press the **OK** button to enter its respective menu.
4. Select the desired setting with the **▲** / **▼** buttons, and press the **OK** button.
5. To exit from the menu, press the [**M**] button.

Slide Show

This function enables you to playback your still images automatically in order one image at a time.

* 3 sec. / 5 sec. / 10 sec.

Protect

Refer to the section in this manual titled “Protecting Images” for further details.

Voice Memo

Refer to the section in this manual titled “Attaching Voice Memos” for further details.

LCD Bright.

Refer to the section in this manual titled “LCD Bright.” in Capture Menu for further details.

Resize

Resizes a previously saved image. Resizing replaces the original image with the changed image. You may only resize to a smaller size.

Quality

Changes the quality (compression) of a recorded image. Compresses images down to half of their size or less, overwrites old size images with newly compressed images. You may only reduce the image quality/size, never increase it.

Copy to Card

Allows you to copy your files from the camera’s internal memory to an SD/SDHC memory card. Of course, you can only do this if you have a memory card installed and have some files in internal memory.

* Cancel / Execute

Setup Menu

Set your camera's operating environment.



1. Press the **[M]** button, and select the [Setup] menu with the **▶** button.
2. Select the desired option item with the **▲ / ▼** buttons, and press the **OK** button to enter its respective menu.
3. Select the desired setting with the **▲ / ▼** buttons, and press the **OK** button.
4. To exit from the menu, press the **[M]** button.

Beep

This sets whether or not to mute camera's beep sound each time you press a button.

* On / Off

Fr. No. Reset

This creates a new folder. The captured images are recorded to the newly created folder from number 0001.

* Cancel / Execute

Auto Off

After a period of camera inactivity, the power to the camera is automatically turned off. This feature is useful for conserving battery power.

* 1 Min. / 2 Min. / 3 Min. / Off

Date/Time

Refer to the section in this manual titled "Setting the Date and Time" for further details.

Sys. Reset

This returns all basic settings to the camera's default settings. The time setting will not be reset.

* Cancel / Execute

Language

Refer to the section in this manual titled "Choosing your Language" for further details.

Light Freq.

This camera supports different lighting frequencies: 50 Hz and 60 Hz. When photographing under fluorescent lighting, select the correct frequency: In the US it is 60 Hz, in the EU and other countries it is 50 Hz. This function is only effective when you set the White Balance to the Fluorescent setting.

* 50 Hz / 60 Hz

Format

Refer to the section in this manual titled "Formatting the Memory Card or Internal Memory" for further details.

Media Info.

This displays the free capacity of the internal memory or the memory card.

System Info.

This displays the firmware version of the camera.

TRANSFERRING FILES TO YOUR COMPUTER

System Requirement

Windows	Macintosh
<ul style="list-style-type: none">■ Pentium III 1GHz or equivalent■ Windows 2000/XP/Vista■ 512MB RAM■ 150MB available hard disk space■ CD-ROM drive■ Available USB port	<ul style="list-style-type: none">■ PowerPC G3/G4/G5■ OS 9.0 or later■ 256MB RAM (512 MB recommended)■ 128MB available hard disk space■ CD-ROM drive■ Available USB port

Downloading Your Files

1. Connect one end of the USB cable to an available USB port on your computer.
2. Connect the other end of the USB cable to the USB terminal on the camera.
3. Turn on your camera.
4. Select [PC] using the ▲ / ▼ buttons and press the **OK** button.
5. From the Windows desktop, double click on "My Computer".
6. Look for a new "removable disk" icon.
 - This "removable disk" is actually the memory (or memory card) in your camera.
Typically, the camera will be assigned drive letter "e" or higher.
7. Double click on the removable disk and locate the DCIM folder.
8. Double click on the DCIM folder to open it to find more folders.
 - Your recorded images and video clips will be inside these folders.
9. Copy & Paste or Drag-N-Drop image and video files to a folder on your computer.

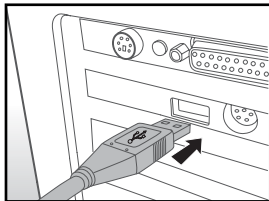

Mac users: Double-click the "untitled" or "unlabeled" disk drive icon on your desktop. iPhoto may automatically launch.

USING THE CAMERA AS A PC CAMERA

Your camera can act as a PC camera, which allows you to videoconference with business associates, or have a real-time conversation with friends or family. To use the camera for videoconferencing, your computer system must include the items as below:

- Microphone
 - Sound card
 - Speakers or headphones
 - Network or Internet connection
1. After installing the PC camera driver (included on the CD-ROM) in your Windows operating system, restart your computer.
 2. Connect one end of the USB cable to the USB terminal of the camera.
 3. Connect the other end of the USB cable to an available USB port on your computer.
 4. Turn on your camera.
 5. Select [PC Camera] with the ▲ / ▼ buttons and press the **OK** button.
 6. Position the camera steadily on top of your computer monitor or use a tripod.
 7. Launch the videoconferencing application software.
 - Simply follow the instructions in the application software to start your camera.



-
- This function is not supported by Mac.
 - The video resolution for videoconferencing applications is generally 320 x 240.
 - For more information about the operation of videoconference application software, refer to its respective help documentation.

EDITING SOFTWARE INSTALLATION

There are 2 types of software that are included on the CD-ROM:

MediaImpression - manages your media for you, and gives you tons of fun and exciting ways to create and share projects featuring your photo, video, and music files. Create your own movies or photo slide shows, complete with soundtrack; edit, enhance, and add fun creative effects to your photos; and share your files easily through simple email attachments or popular photo printing.

Print Creations - brings you a family of fun and easy print-project software that brings out the creativity in you. You can personalize the designs with your own digital pictures and text based on professionally designed templates and layouts. Projects can be printed at home or saved as image files for sharing with family and friends by email or the web.

To install software:

1. Insert the CD-ROM that came with the camera into your CD-ROM drive.
The welcome screen appears.
2. Click the respective software name.
Follow the on-screen instructions to complete the installation.



- For more information about the operation of the software, refer to its respective help documentation.
- For Windows 2000/XP/Vista users, please make sure to install and use the software in "Administrator" mode.
- The software is not supported by Mac.

Questions?

Call our toll-free customer service number. Look for the insert with this icon:

Or visit www.polaroid.com.



SPECIFICATIONS

Item	Description
Image sensor	1/2.5" CMOS sensor (5.0 megapixels)
Image resolution	Still image 7 MB (FW interpolation), 5 MB, 3 MB, 1.3 MB, 0.3 MB (VGA) Video clip 640 x 480 (30 fps), 320 x 240 (30 fps)
LCD display	3.0" full color TFT LCD (230K pixels)
Recording media	16MB internal memory (4MB available for image storage) Supports SD/SDHC memory card (up to 4GB) (optional)
File format	JPEG, DCF 1.1, EXIF 2.2, AVI
Lens	Aperture range: F3 Focal length: 6.47mm (equivalent to 39mm on a 35mm camera)
Focus Range	Standard: 1.45m - infinity (5 feet - infinity) Macro: 0.6m - 1.45m (2 - 5 feet)
Shutter speed	1/2 - 1/1500 sec.
Digital zoom	4x (Capture mode) 4x (Playback mode)
Flash effective range	1.2m - 3.0m (3.9 - 9.8 feet)
Terminals	DV IN 9V USB 2.0 compliant
Power supply	Rechargeable Lithium-ion battery (7.4V) AC power adapter (9V/3A)
Dimensions	Approx. 118 x 76 x 36.5mm (without protruding parts)
Weight	Approx. 285g (without battery and memory card)



















* Design and specifications are subject to change without notice.

APPENDIX





Possible Number of Shots

Possible number of shots (still image)

The table shows the approximate shots that you can capture at each setting based on the capacity of the internal memory and the SD/SDHC memory card.

Size	Quality	Internal Memory	SD/SDHC memory card capacity					
			128MB	256MB	512MB	1GB	2GB	4GB SDHC
 3072 x 2304 (FW interpolation)	 Fine	3	93	187	376	755	1512	3026
	 Standard	4	131	265	533	1068	2138	4279
	 Economy	5	162	327	658	1318	2638	5281
 2560 x 1920	 Fine	4	136	275	552	1106	2214	4432
	 Standard	6	186	375	754	1511	3024	6054
	 Economy	7	207	416	836	1674	3351	6708
 2048 x 1536	 Fine	8	247	497	997	1998	4000	8007
	 Standard	10	273	550	1104	2212	4429	8865
	 Economy	11	319	642	1289	2581	5167	10342
 1280 x 960	 Fine	14	403	811	1628	3261	6527	13064
	 Standard	17	479	964	1934	3873	7752	15514
	 Economy	22	590	1186	2380	4766	9541	19095
VGA 640 x 480	 Fine	26	697	1402	2813	5633	11275	22567
	 Standard	32	853	1714	3438	6885	13781	27582
	 Economy	36	959	1928	3868	7746	15504	31029

Possible recording time / sec (video clip)

Size	Quality	Internal Memory	SD/SDHC memory card capacity					
			128MB	256MB	512MB	1GB	2GB	4GB SDHC
VGA 640 x 480	 Fine	00:04	02:00	04:02	08:05	16:13	32:27	63:11
	 Standard	00:04	02:05	04:11	08:24	16:49	33:40	65:33
 320 x 240	 Fine	00:05	02:32	05:06	10:15	20:32	41:06	80:00
	 Standard	00:06	02:52	05:45	11:33	23:09	46:20	90:11

* We recommend a memory card of at least 10MB/Sec write speed to prevent auto stop or unexpected results. If you experience an error using a slower SD/SDHC memory card, you can set your camera's video recording to QVGA (320 x 240) and standard quality.

Troubleshooting

Refer to the symptoms and solutions listed below before sending the camera for repairs. If the problem persists, contact your local reseller or service center.

Symptom	Cause	Solutions / Corrective Actions
The camera does not come on.	The battery is not inserted.	Insert the battery correctly.
	The battery is dead.	Recharge the battery.
The battery runs out quickly.	The battery is not fully charged. The battery is not used for an extended period of time after being charged.	Fully charge the battery and discharge it for at least one complete cycle before use to maximize its performance and lifetime.
The battery or camera feels warm.	Long period of continuous use of the camera or the flash.	
Even if I press the shutter button, the camera does not take a picture.	The shutter button is not pressed all the way down.	Press the shutter button all the way down.
	The memory card is full.	Insert a new memory card, or delete unwanted files.
	The memory card is write-protected.	Remove the write-protection.
Images do not appear on the LCD display.	LCD display is dark.	Adjust the brightness of the LCD display in the menu.
The images appear to be blurry or out of focus.	The subject is too close.	Get your subject within the effective focus range.
The contents on the memory card cannot be played back.	You played back a memory card that was not formatted by this camera.	Insert a memory card that was formatted on this camera.
Files cannot be deleted.	The file is protected.	Cancel protection.
	The memory card is write-protected.	Remove the write-protection.
Even when the camera's buttons are pressed, it does not operate.	The battery is running low.	Recharge the battery.
The date and time are wrong.	The correct date and time is not set.	Set the correct date and time.
Cannot download images.	The free space on the hard disk in your computer may be insufficient.	Check whether the hard disk has space for running Windows, and if the drive for loading image files has a capacity at least that of the memory card inserted in the camera.
	The battery power may be too low.	Plug in the AC adapter and recharge the battery.

Troubleshooting when using the camera's built-in printer:

Problem	Solution	
	Do not:	Do:
The photo has streaks.	Send another image to be printed.	<ol style="list-style-type: none"> 1. Turn off the camera. 2. Open the paper tray door and remove the photo paper. 3. Place one sheet of photo paper upside down (with watermark facing up) in the paper tray. 4. Close the paper tray door. 5. Press the PRINT button to enter the print menu. 6. Press the OK or PRINT button to process the transaction. 7. Once the ZINK photo paper has ejected, open the paper door and reload the paper. 8. Resume printing. If streaks are still present, then repeat this process.
The paper jammed before printing (nothing has been ejected).	Send another image to be printed.	<ol style="list-style-type: none"> 1. Open the paper tray door. Check if there is paper in the tray. <ul style="list-style-type: none"> ■ If so, ensure the paper is loaded correctly. ■ If not, add a new pack of Polaroid ZINK Photo Paper™.
The paper jammed while printing (part of the image has already ejected).	Pull out paper.	<ol style="list-style-type: none"> 1. Turn off the camera. 2. Open the paper tray door and remove the excess photo paper. 3. Close the paper tray door. 4. Press the print button again. This should eject the jammed paper. 5. Reload the paper after the jammed paper has been cleared.
If all else fails...		<ol style="list-style-type: none"> 1. Turn off the camera. 2. Open the battery/SD card door. 3. Remove the battery and reinsert it. 4. Close the battery/SD card door. 5. Turn on the camera.
Low battery.		Plug the AC adapter to charge the battery and operate the camera to print images.
Out of paper.	Turn off the camera.	Open the paper door and reload a new pack of Zink Photo paper to continue printing or the OK button to cancel printing and return to the PRINT menu.

Quick Printing

Images can also be printed to an external printer.

1. Connect one end of the USB cable to your camera.
2. Connect the other end of the USB cable to the USB port on the printer.
3. Turn on your camera.
4. The [USB] screen is displayed. Select [Quick Print] with the ▲ / ▼ buttons, and press the **OK** button.
5. Select the image that you want to print with the ◀ / ▶ buttons, and press the **OK** button.

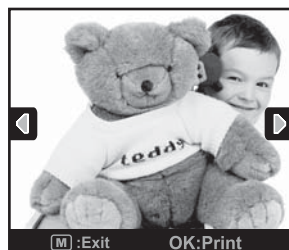

- Do not disconnect the USB cable until entire printing process is complete.
- Do not turn off the camera while printing.
- Do not open the paper tray door while printing.

Connecting to a PictBridge Compliant Printer

If a printer that supports PictBridge is available, images can be printed by connecting the digital still camera directly to the PictBridge-compatible printer without using a computer.

Connecting the camera to the printer

1. Connect one end of the USB cable to your camera.
2. Connect the other end of the USB cable to the USB port on the printer.
3. Turn on your camera.
4. The [USB] screen is displayed. Select [PictBridge] with the \blacktriangle / \blacktriangledown buttons, and press the **OK** button.

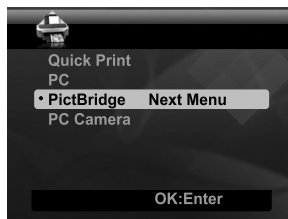

Printing images

When the camera is properly connected to a PictBridge compliant printer, the PictBridge menu is displayed on the display.

1. Select the item you want to configure with the \blacktriangle / \blacktriangledown buttons, and press the **OK** button.
 - [Images]: Select whether you want to print specific image or all images. You may also select printing number for specific image.
 - [Date Print]: According to the printer type, select whether you want to print the image with date imprint or not.
 - [Paper Size]: Select the desired paper size according to the printer type.
 - [Layout]: Select the desired printing layout according to the printer type.
 - [Print]: After all settings are configured, select this item to start printing.
2. If you select [Images] in the previous step, the figure shown on the right hand side will appear. Select [Single] or [All] with the \blacktriangle / \blacktriangledown buttons, and press the **OK** button.
 - [Single]: Select to print one specific image.
 - [All]: Select to print all images.
 - [Exit]: Exit from Images option.

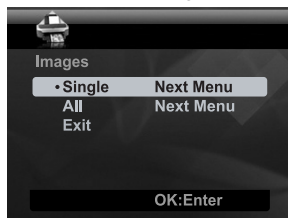
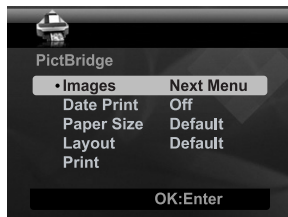

3. If you select [Single] in the previous step, the figure shown on the right hand side will appear.

- Select the image that you want to print with the ◀ / ▶ buttons.
- Select the [Num of Prints] (up to 99) with the ▲ / ▼ buttons.
- After selecting the desired image and printing number, press the **OK** button to confirm.

4. Select [Exit] with the ▲ / ▼ buttons, and press the **OK** button.

5. Select [Print] with the ▲ / ▼ buttons, and press the **OK** button to start printing.

6. The printing starts and the figure shown on the right hand side appears.

- [COMPLETE] will be displayed temporarily, reminding you that the printing procedure is finished.
- If an error is detected during the connection (i.e. the printer hardware problem) between camera and printer, [PRINT ERROR] will be displayed.
- If an error is detected during the communication (i.e. wrong setting on the camera) between camera and printer, [ERROR] will be displayed.

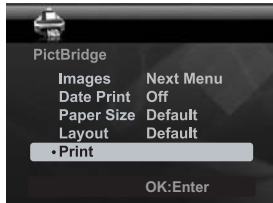
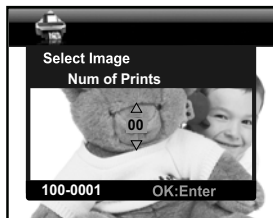

- The image printing may fail if the power to the camera is cut off.
- For service, support and warranty information visit www.polaroid.com.
- "Polaroid" and "Polaroid and Pixel" are trademarks of Polaroid Corporation, USA.

Default Settings

Camera Mode	Menu Item	Default Value
Capture mode	EV	0
	Size	5M
	Quality	Fine
	Sharpness	Normal
	Saturation	Normal
	White Balance	Auto
	ISO	Auto
	Metering	Center
	Color	Normal
	Capture Mode	Single
	LCD Bright.	0
Date Print	Off	
Video mode	Size	VGA
	Quality	Fine
	Color	Normal
	Audio	On
	LCD Bright.	0
Playback mode	Slide Show	3 sec.
	Protect	Single, Set
	Voice Memo	Off
	LCD Bright.	0
	Resize	5M
	Quality	Standard
	Copy to Card	Cancel
Setup mode	Beep	On
	Fr. No. Reset	Cancel
	Auto Off	2 Min.
	Date/Time	MM/DD/YY, 12-Hour
	Sys. Reset	Cancel
	Language	English
	Light Freq.	60 Hz
	Format	Cancel
	Media Info.	-
System Info.	-	



- The default language for the LCD screen may vary with different countries and regions.